

**THE FIRST
ORIGINAL
TRUCK AGM**



UNLOCK YOUR TRUCK'S FULL POTENTIAL.

Your essential guide to VARTA® Heavy Commercial Vehicles Batteries.



Proudly Distributed by
HCB TECHNOLOGIES
New Zealand's Battery Specialists

It all starts with  **VARTA®**

TRUCKS AND BATTERY REQUIREMENTS HAVE CHANGED ENORMOUSLY.

During the past years, commercial vehicles have changed a lot. Not only because of governmental regulations implementing higher emission standards, but also because of more overnight stays, more comfort devices in the cabin and drivetrain, and an increasing tendency to retro-fit additional energy consumers like parking coolers/heaters.

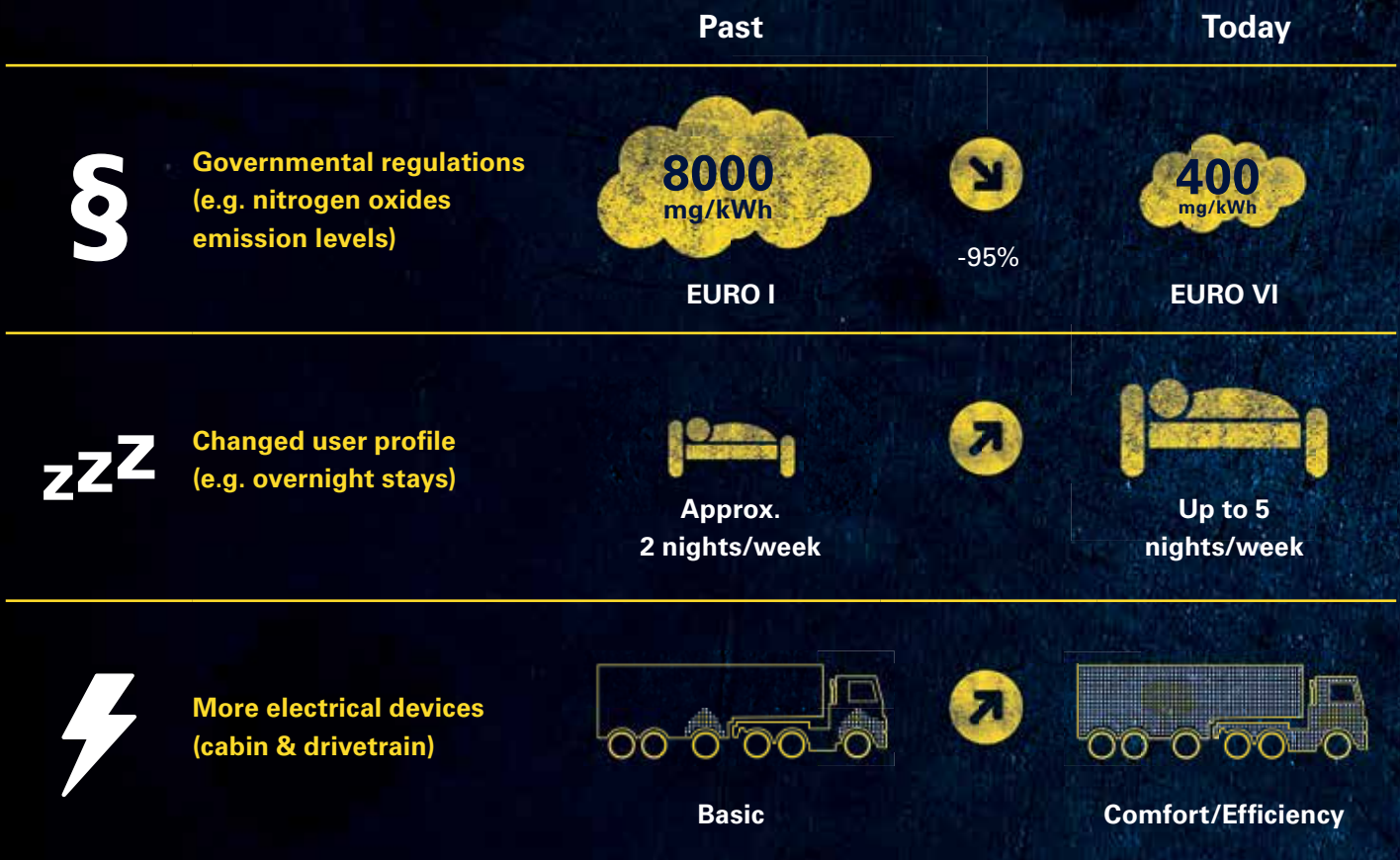

How does this impact the battery?

- ▶ Increased vibration resistance required to cope with end-of-frame installation
- ▶ Demand for enhanced charge acceptance to recharge faster during shorter driving times
- ▶ Larger numbers of cycles required to cope with increased amount of overnight stays
- ▶ Increased depth of discharge to support comfort functions like parking the parking cooler/heater

These higher demands on the batteries mean: fitting a conventional battery to these well-equipped long-haul trucks will lead to a shorter battery lifetime, an increased risk of potential breakdowns and an unnecessary TCO increase as these batteries are not suitable for most modern applications.

The market will continue to develop quickly. Modern trucks will come with start-stop, boosting functions, sailing/coasting and eco-rolling functions. Alongside the trend to increased electrification, the main change will be the further reduction of the engine-on driving time available to recharge the vehicle's battery.

HOW DO THESE CHANGES AFFECT FLEETS?

These changes will challenge fleets in three very important aspects of their business:



1. TOTAL COST OF OWNERSHIP

Conventional batteries fitted in the latest generation of commercial vehicles will lead to a larger number of battery failures, increasing the battery-related TCO. Choosing the correct battery technology for specific applications is an important lever when trying to reduce TCO.



2. RELIABILITY

Only choosing the right battery technology for the various different applications of your fleet can ensure maximum reliability of your fleet's timing commitments. Using the wrong technology increases the risk of breakdowns, resulting in lost delivery slots.



3. EMPLOYEE SATISFACTION

With the rising numbers of overnight stays, truck drivers wish to have a highly equipped vehicle with all fittings and comfort like hoteling functions and parking coolers/heaters. Installing the right battery to handle these power demands goes a long way to ensure employee satisfaction.

VARTA® ProMotive batteries always offer suitable solutions. Like cogwheels, they work together to ensure successful business in the commercial vehicle market: with a reduced TCO, perfect fit, reliable battery technologies for each area of application and satisfied employees.

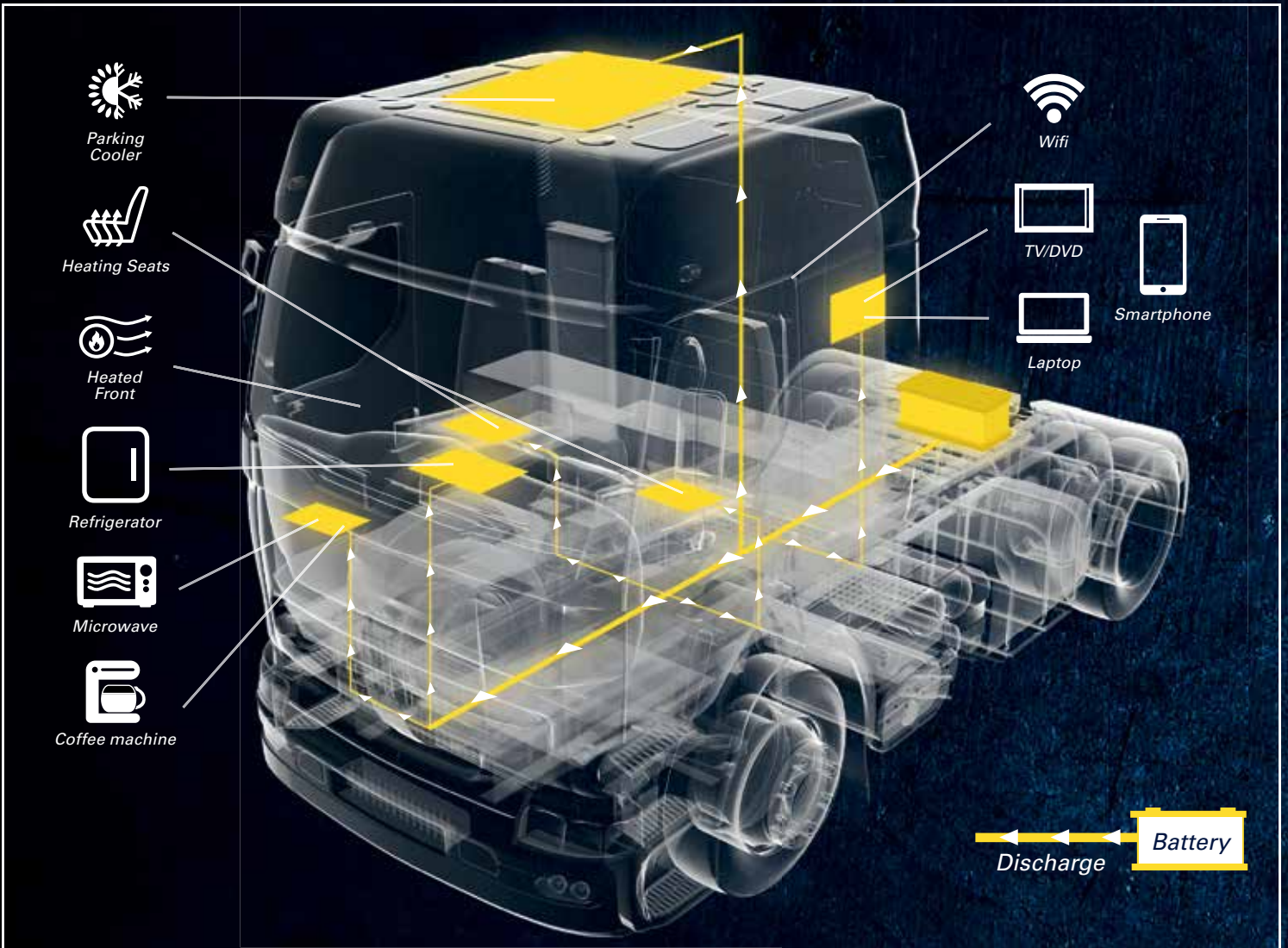

Many electrical devices put a drain on the battery.

In recent years many comfort features such as hoteling functions (sleeping, entertainment, cooking) and parking coolers/heaters have been added. Also, fuel-saving

measures like passive-boost and sailing/coasting need to be powered. These changes put higher drains on the batteries resulting in extensive discharging. To cope with these

changes, battery technology needed to evolve. Therefore VARTA®, the technology market leader and main OE supplier, has developed a new truck battery technology.

VARTA ProMotive AGM.

THE BEST SOLUTION TO OPTIMISE YOUR TCO.

To answer these innovative changes in the commercial vehicle segment, VARTA launches the VARTA ProMotive AGM truck battery: the first original Truck AGM battery which has been developed in collaboration with leading commercial vehicle manufacturers.

Features include: absorbent glass mats ruling out the possibility of battery failures due to acid stratification, the highest vibration resistance, modern fuel-saving functions like start-stop and an ability to deliver reliable performance at even low state of charges.

VARTA PROMOTIVE AGM.



**MADE
IN
GERMANY**

VARTA ProMotive AGM:

- ▶ 6 times the cycle life compared to conventional batteries
- ▶ For advanced hoteling functions with parking cooler/heater
- ▶ Designed for end-of-frame installation (EURO 5/6) due to highest vibration resistance

Unlock your trucks' full potential.

VARTA ProMotive AGM is designed for heavy commercial vehicles. It is the only battery for unlocking the highest demanding applications and power consuming functions including the parking cooler/heater without the battery wearing out and causing downtime.

The new VARTA ProMotive AGM truck battery is not only ready to cope with the challenges of today's technology. It has been designed in collaboration with leading commercial vehicle manufacturers to be ready once today's innovations have become standard features.



Patented **PowerFrame®** grid for reliable starting power, fast recharge and corrosion resistance.



Meets all **original criteria of the commercial vehicle manufacturer.**



For advanced hoteling functions with **parking cooler / heater.**



Highest **vibration resistance.**



Fulfills all of the requirements of **governmental regulations on higher emission standards.**



Suitable for **end-of-frame installation.**

VARTA PROMOTIVE EFB.



**MADE
IN
GERMANY**

VARTA ProMotive EFB:

- ▶ 3 times the cycle life compared to conventional batteries
- ▶ For hoteling functions
- ▶ Designed for end-of-frame installation (EURO 5/6) due to highest vibration resistance

Unlock your trucks' full potential.

The VARTA ProMotive EFB is designed for heavy commercial vehicles. It is made for high energy demands while coping with overnight stays in vehicles with standard hoteling functions. This makes it the right choice for TCO savings.



Patented PowerFrame® grid for reliable starting power, fast recharge and corrosion resistance.



Meets all original criteria of the commercial vehicle manufacturer.



Highest vibration resistance.



Fulfils all of the requirements of governmental regulations on higher emission standards.



Suitable for end-of-frame installation.

VARTA PROMOTIVE SUPER HEAVY DUTY.

VARTA ProMotive Super Heavy Duty:

- ▶ Continuous multi-start
- ▶ Cranking and standard electric demands
- ▶ Ideal vibration resistance for urban distribution applications

Unlock your fleet's full potential.

The VARTA ProMotive Super Heavy Duty is made for commercial vehicles with reliable starting power demands. Our VARTA ProMotive Super Heavy Duty comes in OE quality and helps your fleet do its job.

ENGINEERED
IN
GERMANY



Patented PowerFrame® grid for reliable starting power, fast recharge and corrosion resistance.



Meets all **original criteria of the commercial vehicle manufacturer.**



Vibration resistant.

VARTA PROMOTIVE HEAVY DUTY.

VARTA ProMotive Heavy Duty:

- ▶ Continuous multi-start
- ▶ Cranking and standard electric demands
- ▶ Ideal vibration resistance for agricultural and construction vehicles

Unlock your equipment's full potential.

The VARTA ProMotive Heavy Duty delivers reliable power that can handle a high amount of dust and fertiliser while minimising downtime. The perfect choice for TCO savings.

























ENGINEERED
IN
GERMANY



THE PERFECT BATTERY TECHNOLOGY FOR EVERY VEHICLE AND APPLICATION.

VARTA ProMotive batteries are the first choice for fleet managers, offering a specific solution for every energy demand level. VARTA ProMotive batteries are specifically designed for modern trucks and highly equipped commercial vehicles to meet increasing

requirements of electrical loads, end-of-frame installation and more overnight stays. Our VARTA Truck Portal can assist in identifying the ideal battery technology for your application.

	Demand level	Vibration resistance	Charge acceptance	Cycle life	Depth of discharge
 <p>VARTA ProMotive AGM (Absorbent Glass Mat)</p> <ul style="list-style-type: none"> ➤ 5 or more overnight stays per week ➤ parking cooler/heater ➤ start-stop 	<p>Highest</p> 				
 <p>VARTA ProMotive EFB (Enhanced Flooded Battery)</p> <ul style="list-style-type: none"> ➤ up to 5 overnight stays per week ➤ no parking cooler/heater ➤ no start-stop 	<p>High</p> 				
 <p>VARTA ProMotive SHD (Super Heavy Duty)</p>	<p>Basic</p> 				
 <p>VARTA ProMotive HD (Heavy Duty)</p>	<p>Low</p> 				



REGISTER NOW!
www.varta-automotive.com/fleet

THE VARTA TRUCK PORTAL.

The VARTA Truck Portal is a new service, training and information platform especially for fleet managers of heavy commercial vehicles.

The most important features:

1. Battery Finder

Based on your input the Battery Finder will explain and recommend the best available option for maximum performance and TCO savings.

2. TCO calculator

The TCO calculator will help you to understand the TCO saving potential of choosing the right battery technology.

3. Maintenance

Receive support in how to maintain the batteries in order to get the maximum performance from your application and prolong the service life for maximum TCO saving potential.

4. Knowledge section

This will help you to better understand the role of the battery in the vehicles as well as give valuable insights into various topics in the field of battery technology and market trends to manage the future.

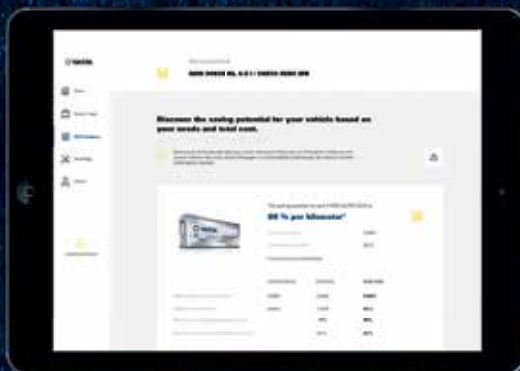

Technical diagrams

Layout

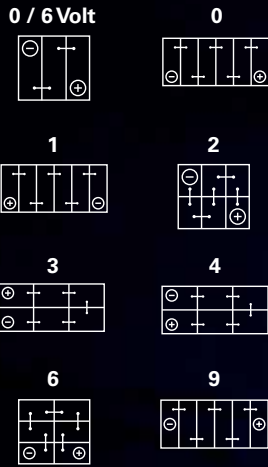

Terminal types

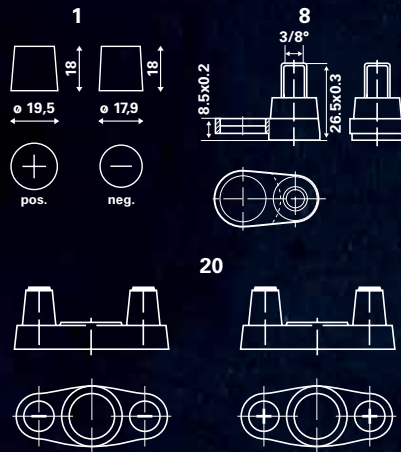

Base hold-down

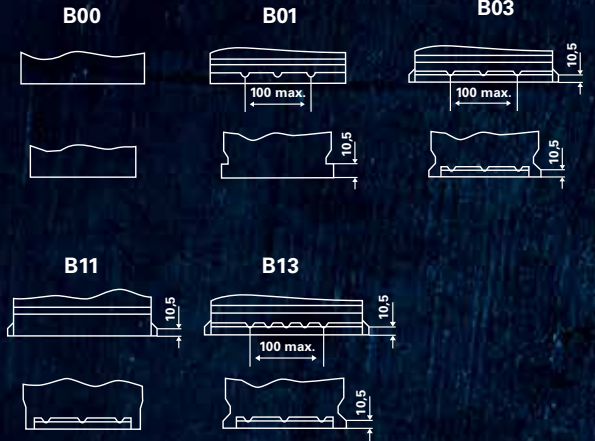

VARTA® ProMotive AGM

VARTA Code	Short Code	Ah (20h)	CCA (EN) [A]	Overall dimensions in mm			Case size	Weight (kg)	Layout	Terminal	Base hold down
				L	W	H					
... E65 2											
710 901 120	A1	210	1200	518	276	242	C	61.0	3	1	B00



VARTA® ProMotive EFB

VARTA Code	Short Code	Ah (20h)	CCA (EN) [A]	Overall dimensions in mm			Case size	Weight (kg)	Layout	Terminal	Base hold down
				L	W	H					
... E65 2											
690 500 105	B90	190	1050	513	223	223	B	46.99	3	1	B00
740 500 120	C40	240	1200	518	276	242	C	59.47	3	1	B00



VARTA® ProMotive Super Heavy Duty

VARTA Code	Short Code	Ah (20h)	CCA (EN) [A]	Overall dimensions in mm			Case size	Weight (kg)	Layout	Terminal	Base hold down
				L	W	H					
... A72 2											
640 400 080	K8	140	800	513	189	223	A	35.76	3	1	B03
645 400 080	K7	145	800	513	189	223	A	37.12	3	1	B00
670 104 100	M9	170	1000	513	223	223	B	44.2	3	1	B03
680 108 100	M18	180	1000	513	223	223	B	44.14	3	1	B00
725 103 115	N9	225	1150	518	276	242	C	57.5	3	1	B00



VARTA® ProMotive Heavy Duty

VARTA Code	Short Code	Ah (20h)	CCA (EN) [A]	Overall dimensions in mm			Case size	Weight (kg)	Layout	Terminal	Base hold down
				L	W	H					
...A74 2											
070 011 030*	E29	70	300	175	167	220	M1	9.35	0	1	B00
112 025 051*	I11	112	510	260	175	238	M4	16.5	0	1	B01
140 023 072*	K13	140	720	260	175	236	M4	19.5	0	1	B01
150 030 076*	L14	150	760	333	175	235	M5	23.8	0	1	B11
200 023 095*	N12	200	950	403	175	235	M6	31.0	0	20	B11
545 200 030	B39	45	300	210	175	175	T4	10.76	0	1	B13
555 064 042	C20	55	420	246	175	190	H5	13.44	0	1	B13
566 047 051	D33	66	510	278	175	190	H6	15.83	0	1	B03
588 038 068	F10	88	680	350	174	189	H8	20.34	0	1	B13
590 040 054	G1	90	540	347	173	234	LOT 7	25.2	0	1	B00
590 041 054	G2	90	540	347	173	234	LOT 7	25.2	1	1	B00
600 035 060	H4	100	600	413	175	220	D	27.43	1	1	B00
600 047 060	H5	100	600	413	175	220	D	26.7	0	1	B00
600 123 072	H9	100	720	313	175	205	GB28	22.34	0	1	B13
605 102 080	H17	105	800	330	172	240	GR31	23.7	9	1	B01
605 103 080	H16	105	800	330	172	240	GR31	23.7	9	8	B01
610 013 076	I2	110	760	514	175	210	MAC110	32.31	3	1	B03
610 048 068	I5	110	680	347	173	234	LOT7	28.58	1	1	B00
610 050 085	I6	110	850	413	175	220	D	29.6	0	1	B03
610 404 068	I18	110	680	347	173	234	LOT7	28.58	0	1	B01
620 047 078	I9	120	780	347	173	234	LOT7	30.91	0	1	B00
620 045 068	I8	120	680	513	189	223	A	33.64	3	1	B00
620 109 076	I16	120	760	510	175	235	MAC120	35.12	4	1	B03
625 012 072	J1	125	720	345	172	285	WOR7	31.22	0	1	B00
625 014 072	J2	125	720	345	172	285	WOR7	31.22	1	1	B00
625 023 000	J3	125	950	286	269	230	NATO	36.8	2	1	B00
630 014 068	J5	130	680	514	218	208	MAC130	37.83	3	1	B00
635 042 068	J8	135	680	360	253	240	12C135	42.3	6	1	B11
635 052 100	J10	135	1000	514	175	210	MAC110	35.46	3	1	B03
643 033 095	K4	143	950	514	218	210	MAC140	39.85	3	1	B03
643 107 090	K11	143	900	508	174	205	MAC132	36.5	0	1	B01
654 011 115	M11	154	1150	513	189	223	A	39.84	3	1	B00
655 013 090	L2	155	900	513	223	223	B	40.98	3	1	B00
655 104 090	L5	155	900	514	218	230	MAC154	42.88	4	1	B03
670 043 100	M6	170	1000	513	223	223	B	43.93	3	1	B00
680 011 140	M12	180	1400	513	223	223	B	46.42	3	1	B00
680 033 110	M7	180	1100	513	223	223	B	44.99	4	1	B03
690 033 120	M10	190	1200	513	223	223	B	44.99	4	1	B03
690 034 120	L3	190	1200	513	223	223	B	45.73	3	1	B03
700 038 105	N2	200	1050	518	276	242	C	53.61	3	1	B00
720 018 115	N5	220	1150	518	291	242	C	56.79	3	1	B00

* 6 Volt * Some batteries available ex-Europe only, enquire with your HCB branch.



FONTERRA'S JOURNEY FROM EXPLODING BATTERIES TO INCREASING FLEET EFFICIENCY

A three-way partnership aimed at improving battery reliability across Fonterra's milk tanker fleet has had health and safety benefits as well as boosting the co-op's bottom line.

A decade ago, when Guy Cooper took up the role of national parts and warranty manager at Fonterra, one of his priorities was tackling a worrying problem with truck batteries in the dairy co-operative's milk tanker fleet.

For a start, battery life was alarmingly short. In the 2010-11 financial year the fleet of 432 trucks chewed through 1422 batteries with some having to be replaced after less than three months.

But more concerning for Guy was that a relatively high number of batteries were exploding, posing an obvious safety hazard

to drivers and mechanics, as well as compromising efficient operations.

"These battery explosions generally happened during jump-starting attempts," he explains.

"While our staff are always wearing PPE in these situations, we clearly didn't want to put anyone at risk with acid and chunks of battery material flying around. It was imperative, from a safety point of view, to address the problem.

"At the same time, with battery life sometimes less than three months, we saw this as an area where we needed to improve reliability, which would result in cost

reductions. Back then, in 2010, we set a target of getting to two years life out of a battery."

Ten years on, Fonterra is well on its way to achieving that goal, thanks to a strong and enduring relationship with its battery supplier, HCB Technologies Ltd, and a history of success with their chosen brand, VARTA®.

Thanks to that relationship, Fonterra – and its drivers – are already enjoying the benefits of VARTA®'s latest and most advanced heavy duty commercial vehicle battery, the ProMotive AGM, introduced in September 2019.

Having been on the market for over a year now, the ProMotive AGM has performed strongly for Fonterra, mirroring a success story that has already been seen in the EMEA region.

A hard-working tanker fleet

In his role as national parts and warranty manager, Guy reports to Fonterra's general manager of national transport, whose division is accountable for the provision of the New Zealand-wide milk collection fleet, currently comprising more than 500 truck and trailer units.

With the tankers operational 24 hours a day, it's one of the hardest working fleets in the world. At peak times, the trucks will make a total of about 3000 journeys a day, collecting milk from almost 9500 farms. Each vehicle travels about 200,000km over the course of a year, meaning the entire fleet clocks up around 95 million km on the road annually.

Those impressive numbers, and the fact that milk collection can't be interrupted, mean that reliability is one of the key tenets around maintaining the fleet, Guy says.



The trucks are equipped with a sophisticated Electronics which control everything from Driver and Engine management, the pickup schedule and mapping through to the onboard sampling and measuring the milk collected at each site. Because of the importance of these systems, Fonterra can't simply go out and hire a replacement vehicle if one of its fleet is unexpectedly off the road.

"When we know there's an issue going on with the fleet, we don't just fix our trucks, we'll do in-depth analysis to define the problem and then we'll carry out a problem solving exercise aimed at improving reliability. We'll then feed our findings back to the manufacturer of the truck or the component concerned," Guy says.

"We work very closely with our suppliers and OEMs (original equipment manufacturers). Over the years we have affected quite a few engineering changes that have been introduced globally.

"We find that because of our high usage and the uniqueness of how our fleet operates – for example our trucks are running empty about 55 percent of the time,

and often on gravel roads, which means they work under some tough conditions – we usually find problems quite early on in a model's life. We feed that back to the manufacturers, and because we can supply good data to demonstrate the root cause, they've got the evidence to make changes."

Demands on truck batteries grows

Around the world, heavy commercial fleet operators are finding the demands on batteries in their vehicles have increased significantly as the amount of onboard electronic equipment continues to grow.

"With our trucks spending a large portion of their time on unsealed roads, and empty, when there's no weight to steady up the suspension, that leads to quite a bit of movement. Sharp shocks in the trucks under these conditions have been measured at up to 9G in the battery box, so the batteries certainly take a hammering," Guy says.

"Another safety aspect is that these batteries are heavy – up to almost 60kg each – so you don't want technicians on the roadside changing them, it's too

much for them to lift. We're at the point now where if there's a failure, the batteries should be able to recover back to site where we can use mechanical handling equipment to make the change so there's no lifting involved."

Fonterra's relationship with HCB

Fonterra's relationship with HCB dates back to 2010 when it asked HCB to participate in a request for proposal process (RFP) for the supply of batteries for the co-op's tanker fleet.

HCB has been New Zealand's battery specialist for 30 years, offering the widest range and the biggest depth of product, and the most knowledgeable people in the industry.

HCB is part of the Bapcor group of companies. Bapcor is the sole distributor for VARTA® batteries in Australasia.

As part of the 2010 RFP process, HCB carried out field testing – included monitoring open circuit voltage, current draw and vibration tests – to assess the performance of the batteries Fonterra was using at the time. Two sets of batteries that had failed

after three and nine months respective usage were torn-down and analysed. HCB then prepared a report on the findings of its testing and analysis, along with a recommendation to switch the fleet to an alternative battery type.

The work resulted in HCB picking up the contract a few months later and following up its initial testing with an 18-month trial to monitor the performance of the new batteries, which showed an impressive success rate of 99.6 percent.

At the same time, HCB worked with Fonterra to carry out site audits of battery handling and charging equipment, developed standard operating procedures, and carried out onsite training with Fonterra staff on safe testing, correct battery handling, preventative care and general battery maintenance.

This resulted in a drop in battery-related safety incidents across the co-op and led to HCB winning the 'Best Safety Initiative Which Enhances Health and Safety Performance at Fonterra' award at Fonterra's 2013 Vendor Awards.

"Early on in our relationship with HCB we also purchased new chargers and modified all our trucks to be fitted with Anderson plugs, the large high-amp charging plugs that fit directly into the side of a vehicle, eliminating the need to lift the battery cover," says Guy.

"We received excellent support from HCB as we set up these changes. That type of support has certainly been one of the benefits we've enjoyed through our relationship with them."

VARTA® delivers performance boost

With the problem of exploding batteries well in the past by 2015, a

desire to continue making performance and reliability improvements saw Fonterra and HCB begin work on transitioning the fleet to VARTA® batteries for the first time.

The VARTA® brand has a strong global reputation for its heavy commercial vehicle batteries and Fonterra initially installed VARTA®'s ProMotive Super Heavy Duty (N9) model across its fleet before moving to the even higher-performing ProMotive EFB (C40) in 2017.

The move to VARTA® resulted in Fonterra's average battery life increasing significantly to around 16-18 months following the introduction of the ProMotive EFB which, like other batteries before it, was trialled in a small number of tankers before its wider deployment across the fleet.

Clarios, the owner and manufacturer of VARTA® branded products, has worked closely with Fonterra and HCB as part of the trials, including making visits to Fonterra sites and organising tear-down analysis of the batteries being trialled.

Clarios are also suppliers to Volvo, the manufacturer of the majority of Fonterra's tankers, which are made in Brisbane.

"We catch up with the Clarios reps once or twice a year. Recently it's been important to have that connection to support Volvo Group Australia to ensure they can supply the battery we want into the trucks that are being built for us in Brisbane," Guy says.

"Through our Clarios contacts we're connecting with Volvo to ensure they have sufficient batteries for the trucks that are coming to New Zealand."

Latest technology set to deliver further improvements

In 2019 the next phase of Fonterra's journey towards achieving its two-year battery life target got underway when it became the first customer in Australasia – and one of the first in the world – to trial VARTA®'s new top-of-the-line heavy commercial vehicle battery, the ProMotive AGM (A1).

The ProMotive AGM

is designed to optimally support drivers and their trucks during their time on the road. Since the demand for nonstop transportation services require trucks to be on the road every day, drivers spend more time in the cabin than ever before, increasing the demand on their vehicles' batteries.

The AGM meets this challenge, offering excellent charge acceptance, extended cycle life and increased depth of discharge. It also has exceptionally high vibration resistance, making it ideally suited for New Zealand roads where the problem of reduced battery life due to vibration has plagued truck and fleet owners.

The ProMotive AGM was initially trialled in three of Fonterra's tankers. One of the three battery pairs was removed and torn down after six months. It was found to be performing on par with a brand-new battery, with no degradation.

A second pair was pulled out and torn down in August 2020 after the truck had travelled 280,000km. While it was showing some signs of

wear and tear, Guy says the degradation was less than expected after that much usage.

The co-op has subsequently fitted 17 more ProMotive AGM pairs across its fleet and is expanding that number further as batteries need replacing.

"The longest running ProMotive AGM – the third of the original three we installed – has now done over 300,000km after about 18 months. It's going well, with no signs of failure, so we're highly confident we'll reach our two-year target with this new model of battery," he says.

"With our next lot of Volvo trucks that are being delivered in 2021, we've specified that they will come fitted with the ProMotive AGM straight out of the factory."

The AGM has already been adopted by many commercial fleets in the EMEA region, proving that it is the first choice with both OE and aftermarket customers. OE manufacturers, such as Volvo, MAN and DAF, have transitioned to AGM in



their portfolios because it is especially designed to fit the needs of today's trucks.

A tried-and-true formula for success

"As well as a focus on safety, within Fonterra's National Transport division our aspiration over many years has been to have the most cost-effective and efficient fleet in the country, and we're well on the way to achieving that," Guy says.

"In terms of the evolution of batteries, we haven't got here by accident. We've always had formal trials, we've defined up-front what success looks like, and then at various stages – whether it's three or six months – we've taken a set of batteries out and HCB have torn them down and done an in-depth inspection to see what condition they're in.

"We measure all aspects of our fleet operations, right down to the individual truck level, so we know which truck is more cost-effective than the others, even though we've got a fleet of over 500.

"Having that data available makes my job

much easier, as does having great vendors like HCB, who listen and understand what we're aiming to achieve. Rather than being in my face, just trying to sell me new products all the time, I feed back to them what's going on and they use that information to come up with a solution for us.

"The end result is that while we're now paying more per unit for our batteries than previously, we're getting significantly improved life, so we're spending less overall."

The benefits of an honest relationship

Guy says Fonterra's relationship with HCB – in line with the way the co-op likes to operate – is about feedback and having an honest communication.

"We could be involved with someone whose sole motive was to sell as many batteries as possible. It's been more a case of us needing a battery technology that's reliable, and gives us the best value option. Our requirements are firstly safety, then reliability and

value to the business.

"The success of our relationship with HCB is demonstrated by the fact we've moved from consuming more than 1400 batteries in a season for a smaller fleet to 300 – it's a huge change over the time. And while those earlier batteries were cheaper, it meant people had to lift a 50kg battery, so it's about the human interaction as well. Having drivers who don't have to touch a battery box for two years is a big achievement, as opposed to every three or six months.

He says the relationship has evolved over the past 10 years.

"It's been great working with them to define where we're going, and they've taken that onboard.

"Individuals come and go, as with any organisation, but the main tenant has remained: that they understand what Fonterra's requirements are, and have always provided the technical ability and the sales ability to meet those demands.

"This is particularly in relation to the fact the

About Fonterra

- A global brand, processing about 83% of New Zealand's milk
- Generate about \$11b into the NZ economy through the milk price
- At peak production, collect about 85 million litres of milk per day, or 16 billion litres a year
- 30 manufacturing sites across New Zealand
- Run a fleet of more than 500 truck and trailer units, operating 24/7

VARTA® product comes from overseas, so getting the right amount of supply into the country can be a challenge, and that's where HCB come into their own because they work very hard in that space, and if a particular battery is not available they'll readily make a suitable alternative available."



HCB Technologies Whangarei

10 Kaka Street, Whangarei
phone: (09) 900 6002

**HCB Technologies
Auckland & Head Office**

19 Timberly Road, Mangere
phone: (09) 622 0033
email: info@hcb.co.nz

HCB Technologies Albany

41A Arrenway Drive, Albany
phone: (09) 479 9420

HCB Technologies Hamilton

690 Arthur Porter Drive, Hamilton
phone: (07) 850 5374

**HCB Technologies
Palmerston North**

14 Matipo Lane, Palmerston North
phone: (06) 354 5868

HCB Technologies Wellington

15 Victoria Street, Petone
phone: (04) 569 5260

**HCB Technologies
Nelson**

85 Vanguard Street, Nelson
phone: (03) 546 8367

**HCB Technologies
Christchurch**

Unit 14, 3 Stark Drive, Wigram
phone: (03) 338 7155

**HCB Technologies
Dunedin**

30 Harrow Street, Dunedin South
phone: (03) 477 1344



It all starts with  **VARTA**

Visit our portal to find your local supplier.
www.varta-automotive.com/en-nz

 CLARIOS



Proudly Distributed By
HCB TECHNOLOGIES
New Zealand's Battery Specialists
www.hcb.co.nz

